

Comfort Glow®

VENT-FREE PROPANE/LP GAS FREESTANDING PEDESTAL STOVE SYSTEM

OWNER'S OPERATION AND INSTALLATION MANUAL

S26PT

20,000 to 26,000 Btu/Hr
Thermostatically-
Controlled

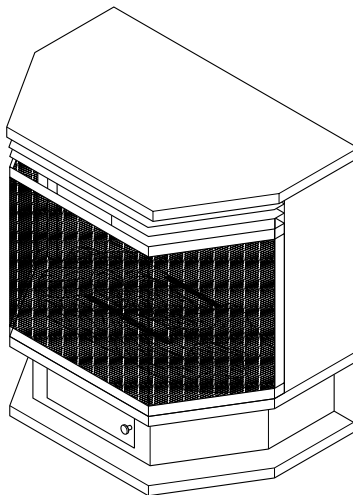

WARNING: If the information in this manual is not followed exactly, a fire or explosion may result causing property damage, personal injury, or loss of life.

- Do not store or use gasoline or other flammable vapors and liquids in the vicinity of this or any other appliance.
- **WHAT TO DO IF YOU SMELL GAS**
 - Do not try to light any appliance.
 - Do not touch any electrical switch; do not use any phone in your building.
 - Immediately call your gas supplier from a neighbor's phone. Follow the gas supplier's instructions.
 - If you cannot reach your gas supplier, call the fire department.
- Installation and service must be performed by a qualified installer, service agency, or the gas supplier.

WARNING: Improper installation, adjustment, alteration, service, or maintenance can cause injury or property damage. Refer to this manual for correct installation and operational procedures. For assistance or additional information consult a qualified installer, service agency, or the gas supplier.

WARNING: This is an unvented gas-fired heater. It uses air (oxygen) from the room in which it is installed. Provisions for adequate combustion and ventilation air must be provided. Refer to *Air for Combustion and Ventilation* section on page 4 of this manual.

This appliance may be installed in an aftermarket*, permanently located, manufactured (mobile) home, where not prohibited by local codes.

This appliance is only for use with the type of gas indicated on the rating plate. This appliance is not convertible for use with other gases.

*Aftermarket: Completion of sale, not for purpose of resale, from the manufacturer

Save this manual for future reference.

VENT-FREE PROPANE/LP PEDESTAL STOVE

SAFETY INFORMATION

⚠️ WARNINGS

IMPORTANT: Read this owner's manual carefully and completely before trying to assemble, operate, or service this heater. Improper use of this heater can cause serious injury or death from burns, fire, explosion, electrical shock, and carbon monoxide poisoning.

⚠️ DANGER: Carbon monoxide poisoning may lead to death!

Carbon Monoxide Poisoning: Early signs of carbon monoxide poisoning resemble the flu, with headaches, dizziness, or nausea. If you have these signs, the heater may not be working properly. **Get fresh air at once!** Have heater serviced. Some people are more affected by carbon monoxide than others. These include pregnant women, people with heart or lung disease or anemia, those under the influence of alcohol, and those at high altitudes.

Propane/LP Gas: Propane/LP gas is odorless. An odor-making agent is added to propane/LP gas. The odor helps you detect a propane/LP gas leak. However, the odor added to propane/LP gas can fade. Propane/LP gas may be present even though no odor exists.

Make certain you read and understand all warnings. Keep this manual for reference. It is your guide to safe and proper operation of this heater.

⚠️ WARNING: Any change to this fireplace or its controls can be dangerous.

⚠️ WARNING: Do not allow fans to blow directly into the heater. Avoid any drafts that alter burner flame patterns. Ceiling fans can create drafts that alter burner flame patterns. Altered burner patterns can cause sooting.

⚠️ WARNING: Do not use a blower insert, heat exchanger insert, or other accessory not approved for use with this heater.

Due to high temperatures, the appliance should be located out of traffic and away from furniture and draperies.

Do not place clothing or other flammable material on or near the appliance. Never place any objects in the fireplace.

Heater becomes very hot when running fireplace. Keep children and adults away from hot surfaces to avoid burns or clothing ignition. Fireplace will remain hot for a time after shutdown. Allow surfaces to cool before touching.

Carefully supervise young children when they are in the room with fireplace.

You must operate this heater with the heater screen in place. Make sure heater screen is in place before running heater.

Keep the appliance area clear and free from combustible materials, gasoline, and other flammable vapors and liquids.

1. This appliance is only for use with the type of gas indicated on the rating plate. This appliance is not convertible for use with other gases.
2. Do not place propane/LP supply tank(s) inside any structure. Locate propane/LP supply tank(s) outdoors.
3. If you smell gas
 - shut off gas supply
 - do not try to light any appliance
 - do not touch any electrical switch; do not use any phone in your building
 - immediately call your gas supplier from a neighbor's phone. Follow the gas supplier's instructions
 - if you cannot reach your gas supplier, call the fire department

4. This heater shall not be installed in a bedroom or bathroom.
5. Do not use this heater as a wood-burning heater. Use only the logs provided with the heater.
6. Do not add extra logs or ornaments such as pine cones, vermiculite, or rock wool. Using these added items can cause sooting. Do not add lava rock around base. Rock and debris could fall into the control area of heater. After servicing, always replace screen before operating heater.
7. You must operate this heater with the heater screen in place. Make sure heater screen is in place before running heater.
8. This heater is designed to be smokeless. If logs ever appear to smoke, turn off heater and call a qualified service person. *Note:* During initial operation, slight smoking could occur due to log curing and heater burning manufacturing residues.
9. To prevent the creation of soot, follow the instructions in *Cleaning and Maintenance*, page 13.
10. Before using furniture polish, wax, carpet cleaner, or similar products, turn heater off. If heated, the vapors from these products may create a white powder residue within burner box or on adjacent walls or furniture.
11. This heater needs fresh air ventilation to run properly. This heater has an Oxygen Depletion Sensing (ODS) safety shutoff system. The ODS shuts down the heater if not enough fresh air is available. See *Air for Combustion and Ventilation*, pages 4 through 6. If heater keeps shutting off, see *Troubleshooting*, pages 14 through 16.
12. Do not run heater
 - where flammable liquids or vapors are used or stored.
 - under dusty conditions.
13. Do not use this heater to cook food or burn paper or other objects.
14. Do not use heater if any part has been under water. Immediately call a qualified service technician to inspect the room heater and to replace any part of the control system and any gas control which has been under water.

OWNER'S MANUAL

SAFETY INFORMATION

Continued

15. Turn off and unplug heater and let cool before servicing. Only a qualified service person should service and repair heater.
16. Operating heater above elevations of 4,500 feet could cause pilot outage.
17. Do not operate heater if any log is broken. Do not operate heater if a log is chipped (dime-sized or larger).
18. To prevent performance problems, do not use propane/LP fuel tank of less than 100 lbs. capacity.

LOCAL CODES

Install and use heater with care. Follow all local codes. In the absence of local codes, use the latest edition of *The National Fuel Gas Code, ANSZ223.1*, also known as NFPA 54*.

*Available from:

American National Standards Institute, Inc.
1430 Broadway
New York, NY 10018

National Fire Protection Association, Inc.
Batterymarch Park
Quincy, MA 02269

This heater is designed for vent-free operation. State and local codes in some areas prohibit the use of vent-free heaters.

UNPACKING

1. Remove top inner pack.
2. Tilt carton so that stove is upright.
3. Remove protective side packaging.
4. Slide stove out of carton.
5. Remove protective plastic wrap.
6. Remove screen by lifting and then pulling forward.
7. Remove log set by cutting plastic ties.
8. Carefully unwrap log.
9. Check for any shipping damage. If stove or log is damaged, promptly inform dealer where you bought stove.

PRODUCT IDENTIFICATION

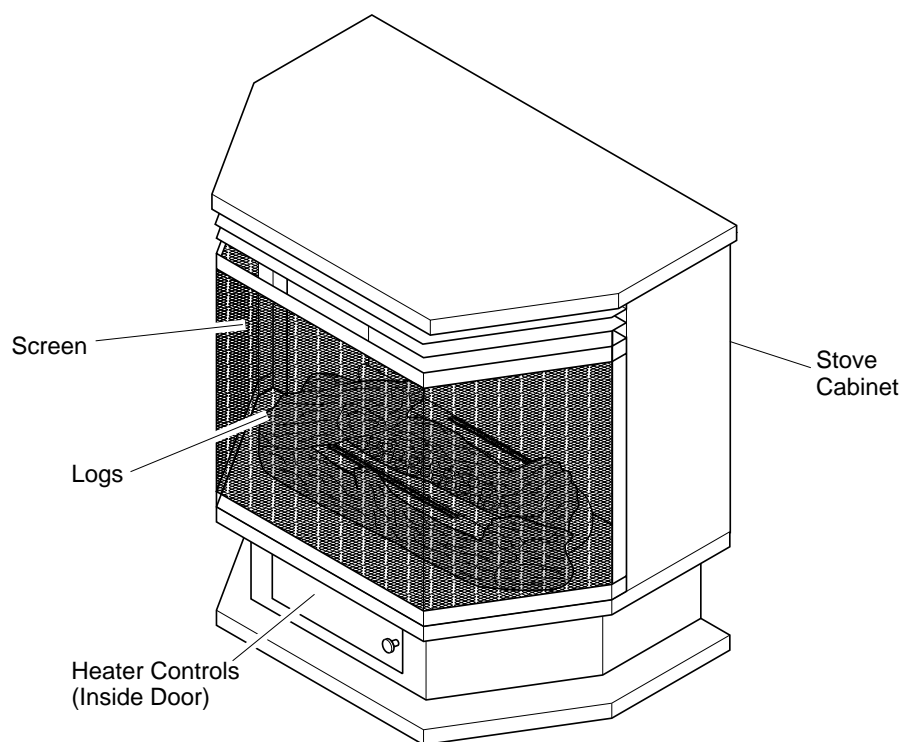

Figure 1 - Vent-Free Propane/LP Gas Stove

PRODUCT FEATURES

SAFETY PILOT

This heater has a pilot with an Oxygen Depletion Sensing (ODS) safety shutoff system. The ODS/pilot is a required feature for vent-free room heaters. The ODS/pilot shuts off the heater if there is not enough fresh air.

PIEZO IGNITION SYSTEM

This heater has a piezo ignitor. This system requires no matches, batteries, or other sources to light heater.

VENT-FREE PROPANE/LP PEDESTAL STOVE

AIR FOR COMBUSTION AND VENTILATION

⚠ WARNING: This heater shall not be installed in a confined space or unusually tight construction unless provisions are provided for adequate combustion and ventilation air. Read the following instructions to insure proper fresh air for this and other fuel-burning appliances in your home.

Today's homes are built more energy efficient than ever. New materials, increased insulation, and new construction methods help reduce heat loss in homes. Home owners weather strip and caulk around windows and doors to keep the cold air out and the warm air in. During heating months, home owners want their homes as airtight as possible.

While it is good to make your home energy efficient, your home needs to breathe. Fresh air must enter your home. All fuel-burning appliances need fresh air for proper combustion and ventilation.

Exhaust fans, heaters, clothes dryers, and fuel burning appliances draw air from the house to operate. You must provide adequate fresh air for these appliances. This will insure proper venting of vented fuel-burning appliances.

PROVIDING ADEQUATE VENTILATION

The following are excerpts from *National Fuel Gas Code, NFPA 54/ANS Z223.1, Section 5.3, Air for Combustion and Ventilation*.

All spaces in homes fall into one of the three following ventilation classifications:

1. Unusually Tight Construction
2. Unconfined Space
3. Confined Space

The information on pages 4 through 6 will help you classify your space and provide adequate ventilation.

Unusually Tight Construction

The air that leaks around doors and windows may provide enough fresh air for combustion and ventilation. However, in buildings of unusually tight construction, you must provide additional fresh air.

Unusually tight construction is defined as construction where:

- a. walls and ceilings exposed to the outside atmosphere have a continuous water vapor retarder with a rating of one perm (6×10^{-11} kg per pa-sec- m^2) or less with openings gasketed or sealed **and**
- b. weather stripping has been added on openable windows and doors **and**
- c. caulking or sealants are applied to areas such as joints around window and door frames, between sole plates and floors, between wall-ceiling joints, between wall panels, at penetrations for plumbing, electrical, and gas lines, and at other openings.

If your home meets all of the three criteria above, you must provide additional fresh air. See *Ventilation Air From Outdoors*, page 6.

If your home does not meet all of the three criteria above, proceed to *Determining Fresh-Air Flow For Heater Location*, page 5.

Confined and Unconfined Space

The National Fuel Gas Code, ANS Z223.1 defines a confined space as a space whose volume is less than 50 cubic feet per 1,000 Btu per hour (4.8 m³ per kw) of the aggregate input rating of all appliances installed in that space and an unconfined space as a space whose volume is not less than 50 cubic feet per 1,000 Btu per hour (4.8 m³ per kw) of the aggregate input rating of all appliances installed in that space. Rooms communicating directly with the space in which the appliances are installed*, through openings not furnished with doors, are considered a part of the unconfined space.

This heater shall not be installed in a confined space or unusually tight construction unless provisions are provided for adequate combustion and ventilation air.

* Adjoining rooms are communicating only if there are doorless passageways or ventilation grills between them.

AIR FOR COMBUSTION AND VENTILATION

Continued

DETERMINING FRESH-AIR FLOW FOR HEATER LOCATION

Determining if You Have a Confined or Unconfined Space

Use this worksheet to determine if you have a confined or unconfined space.

Space: Includes the room in which you will install heater plus any adjoining rooms with doorless passageways or ventilation grills between the rooms.

1. Determine the volume of the space (length x width x height).

Length x Width x Height = _____ cu. ft. (volume of space)

Example: Space size 20 ft. (length) x 16 ft. (width) x 8 ft. (ceiling height) = 2560 cu. ft. (volume of space)

If additional ventilation to adjoining room is supplied with grills or openings, add the volume of these rooms to the total volume of the space.

2. Divide the space volume by 50 cubic feet to determine the maximum Btu/Hr the space can support.

_____ (volume of space) ÷ 50 cu. ft. = (Maximum Btu/Hr the space can support)

Example: 2560 cu. ft. (volume of space) ÷ 50 cu. ft. = 51.2 or 51,200 (maximum Btu/Hr the space can support)

3. Add the Btu/Hr of all fuel burning appliances in the space.

Vent-free heater _____ Btu/Hr

Gas water heater* _____ Btu/Hr

Gas furnace _____ Btu/Hr

Vented gas heater _____ Btu/Hr

Gas heater logs _____ Btu/Hr

Other gas appliances* + _____ Btu/Hr

Total = _____ Btu/Hr

Example:

Gas water heater 30,000 Btu/Hr

Vent-free heater + 26,000 Btu/Hr

Total = 56,000 Btu/Hr

* Do not include direct-vent gas appliances. Direct-vent draws combustion air from the outdoors and vents to the outdoors.

4. Compare the maximum Btu/Hr the space can support with the actual amount of Btu/Hr used.

_____ Btu/Hr (maximum the space can support)

_____ Btu/Hr (actual amount of Btu/Hr used)

Example: 51,200 Btu/Hr (maximum the space can support)

56,000 Btu/Hr (actual amount of Btu/Hr used)

The space in the above example is a confined space because the actual Btu/Hr used is more than the maximum Btu/Hr the space can support. You must provide additional fresh air. Your options are as follows:

- A. Rework worksheet, adding the space of an adjoining room. If the extra space provides an unconfined space, remove door to adjoining room or add ventilation grills between rooms. See *Ventilation Air From Inside Building*, page 6.
- B. Vent room directly to the outdoors. See *Ventilation Air From Outdoors*, page 6.
- C. Install a lower Btu/Hr heater, if lower Btu/Hr size makes room unconfined.

If the actual Btu/Hr used is less than the maximum Btu/Hr the space can support, the space is an unconfined space. You will need no additional fresh air ventilation.

⚠ WARNING: If the area in which the heater may be operated is smaller than that defined as an unconfined space or if the building is of unusually tight construction, provide adequate combustion and ventilation air by one of the methods described in the *National Fuel Gas Code, ANS Z223.1, Section 5.3* or applicable local codes.

Continued

VENT-FREE PROPANE/LP PEDESTAL STOVE

AIR FOR COMBUSTION AND VENTILATION

Continued

VENTILATION AIR

Ventilation Air From Inside Building

This fresh air would come from an adjoining unconfined space. When ventilating to an adjoining unconfined space, you must provide two permanent openings: one within 12" of the ceiling and one within 12" of the floor on the wall connecting the two spaces (see options 1 and 2, Figure 2). You can also remove door into adjoining room (see option 3, Figure 2). Follow the *National Fuel Gas Code, NFPA 54/ANS Z223.1, Section 5.3, Air for Combustion and Ventilation* for required size of ventilation grills or ducts.

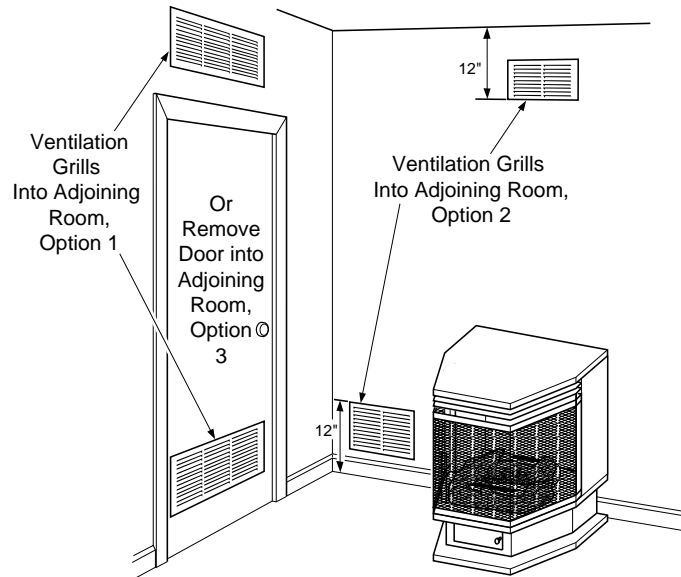

Figure 2 - Ventilation Air from Inside Building

⚠ WARNING: Rework worksheet, adding the space of the adjoining unconfined space. The combined spaces must have enough fresh air to supply all appliances in both spaces.

Ventilation Air From Outdoors

Provide extra fresh air by using ventilation grills or ducts. You must provide two permanent openings: one within 12" of the ceiling and one within 12" of the floor. Connect these items directly to the outdoors or spaces open to the outdoors. These spaces include attics and crawl spaces. Follow the *National Fuel Gas Code, NFPA 54/ANS Z223.1, Section 5.3, Air for Combustion and Ventilation* for required size of ventilation grills or ducts.

IMPORTANT: Do not provide openings for inlet or outlet air into attic if attic has a thermostat-controlled power vent. Heated air entering the attic will activate the power vent.

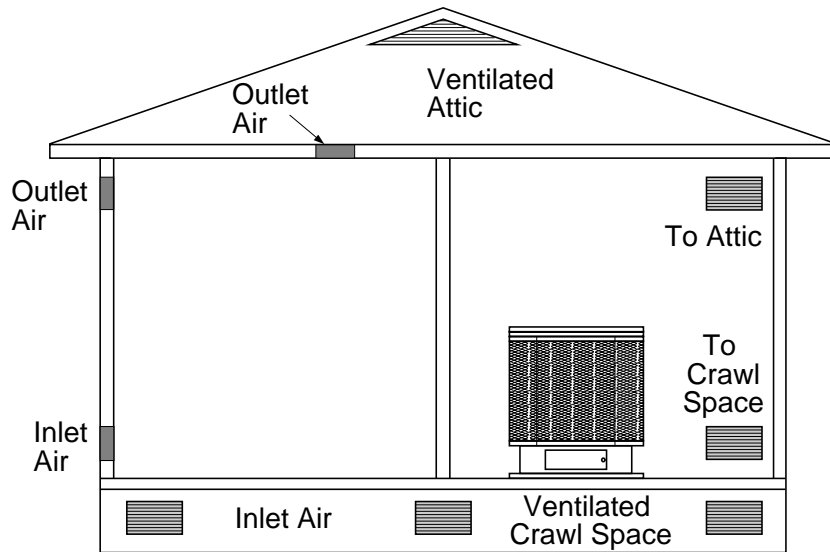

Figure 3 - Ventilation Air from Outdoors

INSTALLATION

NOTICE: This heater is intended for use as supplemental heat. Use this heater along with your primary heating system. Do not install this heater as your primary heat source. If you have a central heating system, you may run system's circulating blower while using heater. This will help circulate the heat throughout the house. In the event of a power outage, you can use this heater as your primary heat source.

WARNING: A qualified service person must install heater. Follow all local codes.

WARNING: Never install the heater

- in a bedroom or bathroom
- in a recreational vehicle
- where curtains, furniture, clothing, or other flammable objects are less than 42 inches from the front, top, or sides of the heater
- in high traffic areas
- in windy or drafty areas

CAUTION: This heater creates warm air currents. These currents move heat to wall surfaces next to heater. Installing heater next to vinyl or cloth wall coverings or operating heater where impurities (such as tobacco smoke, aromatic candles, cleaning fluids, oil or kerosene lamps, etc.) in the air exist, may discolor walls.

IMPORTANT: Vent-free heaters add moisture to the air. Although this is beneficial, installing heater in rooms without enough ventilation air may cause mildew to form from too much moisture. See *Air for Combustion and Ventilation*, pages 4 through 6.

CHECK GAS TYPE

Use only propane/LP gas. If your gas supply is not propane/LP gas, do not install heater. Call dealer where you bought heater for proper type heater.

CLEARANCES TO COMBUSTIBLES (Vent-Free Operation Only)

WARNING: Maintain the minimum clearances. If you can, provide greater clearances from floor, ceiling, and adjoining side and back walls.

Carefully follow the instructions below. This stove is a freestanding unit designed to set directly on the floor. **IMPORTANT:** You must maintain minimum wall and ceiling clearances during installation. The minimum clearances are shown in Figure 4. Measure from outermost point of stove top.

Minimum Wall and Ceiling Clearances (see Figure 4)

- Clearances from outermost point of stove top to any combustible side wall should not be less than 12 inches.
- Clearances from outermost point of stove top to any combustible back wall should not be less than 6 inches (Includes corner installations).
- Clearances from the stove top to the ceiling should not be less than 48 inches.

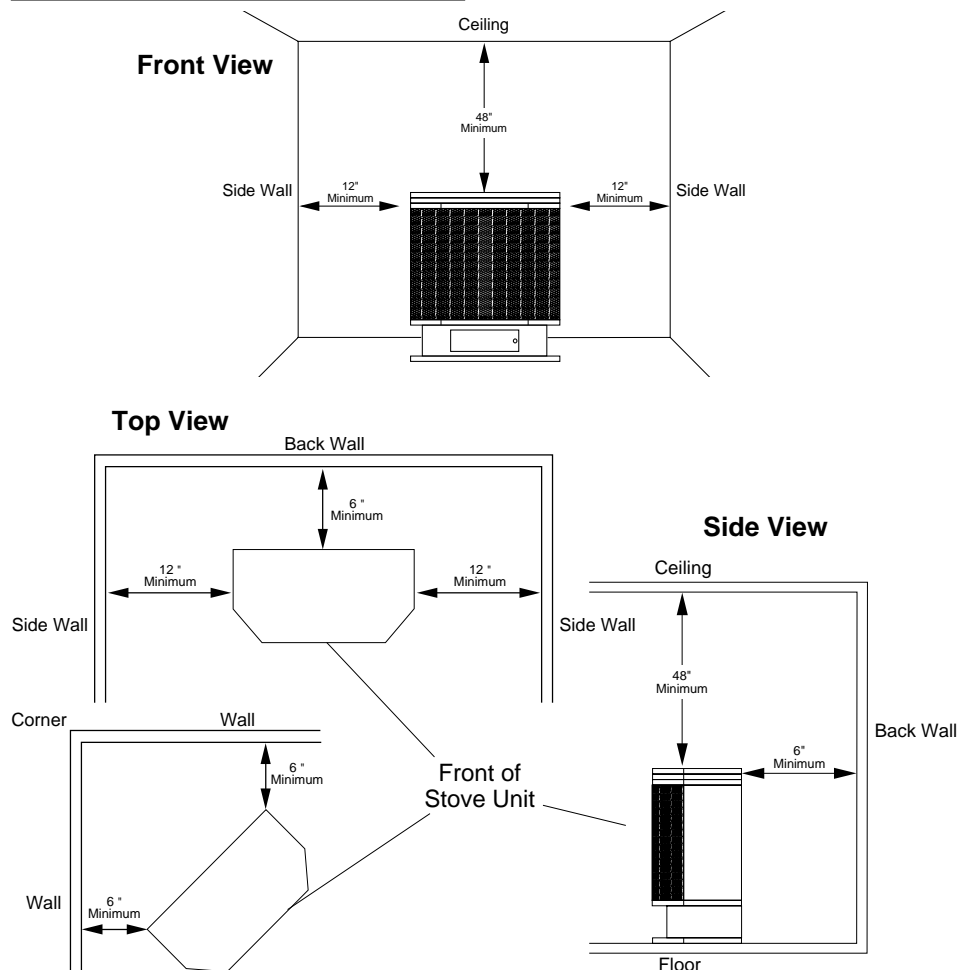

Figure 4 - Minimum Clearance to Walls and Ceiling

Continued

VENT-FREE PROPANE/LP PEDESTAL STOVE

INSTALLATION

Continued

CONNECTING TO GAS SUPPLY

⚠ WARNING: A qualified service person must connect heater to gas supply. Follow all local codes.

⚠ CAUTION: Never connect heater directly to the propane/LP supply. This heater requires an external regulator (not supplied). Install the external regulator between the heater and propane/LP supply.

Installation Items Needed

Before installing heater, make sure you have the items listed below.

- piping (check local codes)
- sealant (resistant to propane/LP gas)
- equipment shutoff valve *
- test gauge connection *
- sediment trap
- tee joint
- pipe wrench

* An CSA design-certified equipment shutoff valve with 1/8" NPT tap is an acceptable alternative to test gauge connection. Purchase the optional CSA design-certified equipment shutoff valve from your dealer. See *Accessories*, page 22.

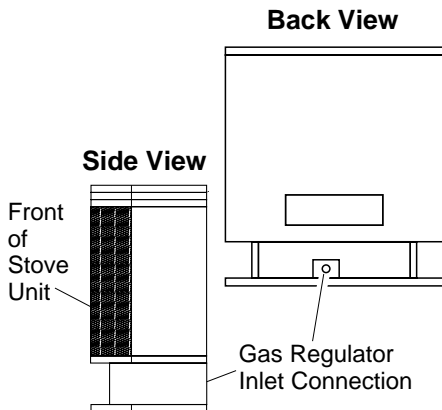

Figure 5 - Gas Regulator Location and Gas Line Access Into Stove Cabinet

The installer must supply an external regulator. The external regulator will reduce incoming gas pressure. You must reduce incoming gas pressure to between 11 and 14 inches of water. If you do not reduce incoming gas pressure, heater regulator damage could occur. Install external regulator with the vent pointing down as shown in Figure 6. Pointing the vent down protects it from freezing rain or sleet.

⚠ WARNING: Never connect heater to private (non-utility) gas wells. This gas is commonly known as wellhead gas.

⚠ CAUTION: Use only new, black iron or steel pipe. Internally-tinned copper tubing may be used in certain areas. Check your local codes. Use pipe of 1/2" diameter or greater to allow proper gas volume to heater. If pipe is too small, undue loss of pressure will occur.

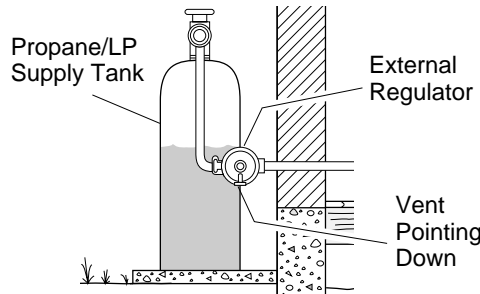

Figure 6 - External Regulator With Vent Pointing Down

Installation must include an equipment shutoff valve, union, and plugged 1/8" NPT tap. Locate NPT tap within reach for test gauge hook up. NPT tap must be upstream from heater (see Figure 7).

IMPORTANT: Install equipment shutoff valve in an accessible location. The equipment shutoff valve is for turning on or shutting off the gas to the appliance.

Apply pipe joint sealant lightly to male threads. This will prevent excess sealant from going into pipe. Excess sealant in pipe could result in clogged heater valves.

⚠ CAUTION: Use pipe joint sealant that is resistant to liquid petroleum (LP) gas.

We recommend that you install a sediment trap in supply line as shown in Figure 7. Locate sediment trap where it is within reach for cleaning. Install in piping system between fuel supply and heater. Locate sediment trap where trapped matter is not likely to freeze. A sediment trap traps moisture and contaminants. This keeps them from going into heater controls. If sediment trap is not installed or is installed wrong, heater may not run properly.

⚠ CAUTION: Avoid damage to regulator. Hold gas regulator with wrench when connecting it to gas piping and/or fittings.

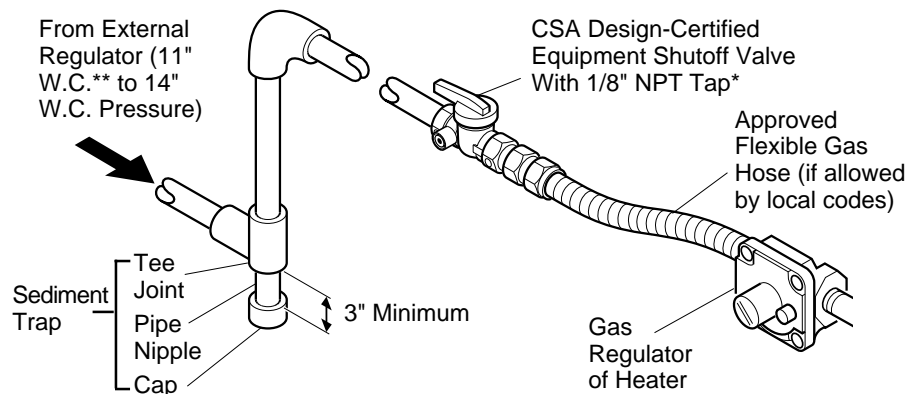

Figure 7 - Gas Connection

* Purchase the optional CSA design-certified equipment shutoff valve from your dealer. See *Accessories*, page 22.

** Minimum inlet pressure for purpose of input adjustment.

INSTALLATION

Continued

CHECKING GAS CONNECTIONS

⚠ WARNING: Test all gas piping and connections for leaks after installing or servicing. Correct all leaks at once.

⚠ WARNING: Never use an open flame to check for a leak. Apply a mixture of liquid soap and water to all joints. Bubbles forming show a leak. Correct all leaks at once.

⚠ CAUTION: Make sure external regulator has been installed between propane/LP supply and heater. See guidelines under *Connecting to Gas Supply*, page 8.

Pressure Testing Gas Supply Piping System

Test Pressures In Excess Of 1/2 PSIG (3.5 kPa)

1. Disconnect heater with its appliance main gas valve (control valve) and equipment shutoff valve from gas supply piping system. Pressures in excess of 1/2 psig will damage heater regulator.
2. Cap off open end of gas pipe where equipment shutoff valve was connected.
3. Pressurize supply piping system by either using compressed air or opening propane/LP supply tank valve.
4. Check all joints of gas supply piping system. Apply mixture of liquid soap and water to gas joints. Bubbles forming show a leak.
5. Correct all leaks at once.
6. Reconnect heater and equipment shutoff valve to gas supply. Check reconnected fittings for leaks.

Test Pressures Equal To or Less Than 1/2 PSIG (3.5 kPa)

1. Close equipment shutoff valve (see Figure 8).
2. Pressurize supply piping system by either using compressed air or opening propane/LP supply tank valve.
3. Check all joints from gas meter to equipment shutoff valve (see Figure 9). Apply mixture of liquid soap and water to gas joints. Bubbles forming show a leak.
4. Correct all leaks at once.

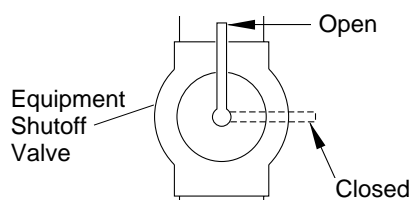

Figure 8- Equipment Shutoff Valve

Pressure Testing Heater Gas Connections

1. Open equipment shutoff valve (see Figure 8).
2. Open propane/LP supply tank valve.
3. Make sure control knob of heater is in the OFF position.
4. Check all joints from equipment shutoff valve to control valve (see Figure 9). Apply mixture of liquid soap and water to gas joints. Bubbles forming show a leak.
5. Correct all leaks at once.
6. Light heater (see *Operating Heater*, pages 11 and 12). Check all other internal joints for leaks.
7. Turn off heater (see *To Turn Off Gas to Appliance*, page 12).

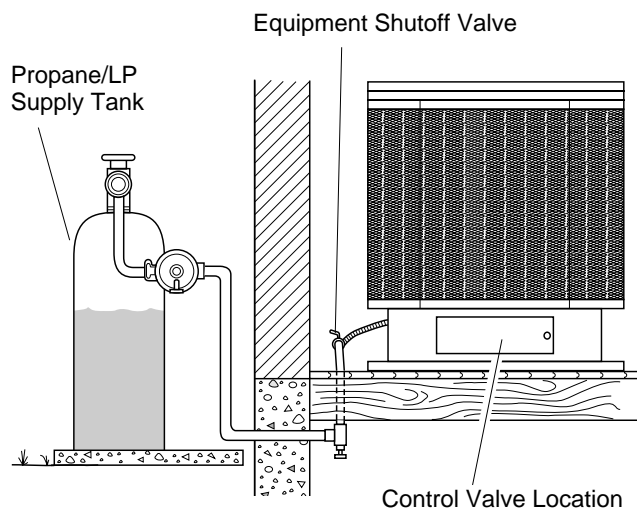

Figure 9 - Checking Gas Joints

Continued

VENT-FREE PROPANE/LP PEDESTAL STOVE

INSTALLATION

Continued

INSTALLING LOGS

⚠ WARNING: Failure to position the parts in accordance with these diagrams or failure to use only parts specifically approved with this heater may result in property damage or personal injury.

⚠ CAUTION: After installation and periodically thereafter, check to ensure that no flame comes in contact with any log. With the heater set to High, check to see if flames contact any log. If so, reposition logs according to the log installation instructions in this manual. Flames contacting logs will create soot.

It is very important to install the logs exactly as instructed. Do not modify logs. Only use logs supplied with heater.

Place one-piece log set on grate to fit as illustrated in Figure 10. Make sure log sits flat on firebox floor (see Figure 10). **IMPORTANT:** Make sure log does not cover any burner ports (see Figure 11).

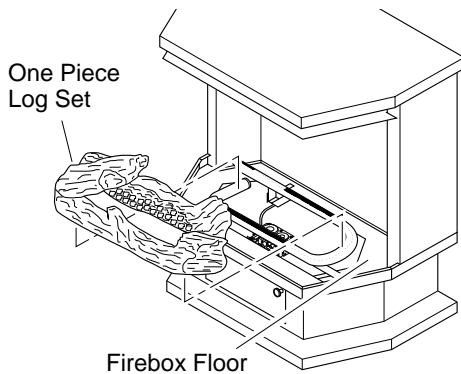

Figure 10 - Installing One-Piece Log Set

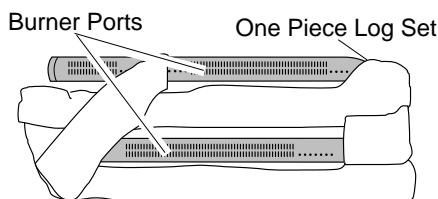

Figure 11 - Installing One-Piece Log set (Top View)

INSTALLING BLOWER ACCESSORY - GA3750

Tools required: Phillips screwdriver

NOTICE: Shut off gas heater during the following blower installation.

1. Remove top panel of stove by removing three screws from under top lip on each side of stove (see Figure 12).
2. Facing front of stove, carefully slide top panel forward until it is completely removed from stove (see Figure 12).
3. Disconnect power cord wires from blower motor (if connected) (see Figure 13).
4. Disconnect green ground wire from blower housing (if connected) by removing screw holding wire terminal (see Figure 13).

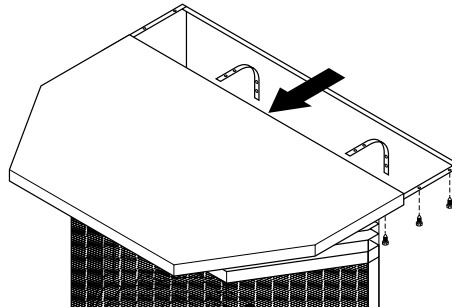

Figure 12 - Removing Stove Top Panel

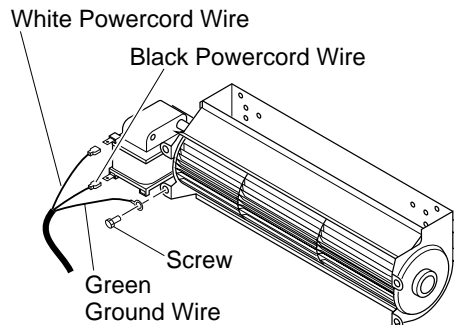

Figure 13 - Removing Wires from Blower

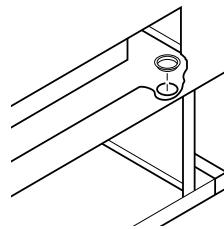

Figure 14 - Installing Bushing

5. Install one plastic bushing provided in blower kit into the 1 1/2" hole in the left rear of firebox floor. Access hole through the rectangular opening in the rear panel (see Figure 14).
6. Remove the two blower mounting brackets from the rear panel by removing two screws each (see Figure 15).
7. Attach the two mounting brackets to blower housing using four screws provided in blower kit (2 for each bracket) (see Figure 15). Tighten screws securely. Place blower assembly temporarily on top of firebox.
8. Working from the rear of the stove, place entire power cord, including speed control housing, in lower control compartment.
9. Route ends of 3-wire power cord up from the lower control compartment through the plastic bushing, then up to the upper cavity of stove (see Figure 16, page 11).
10. Attach the terminal ends of the white and black power cord wires to the terminals on the blower motor (see Figure 13). Push firmly.
11. Attach the terminal end of the green power cord wire to the front tab of the blower housing using screw provided (see Figure 13).
12. Using the four screws previously removed, mount blower assembly to stove by reattaching blower brackets to rear panel (see Figure 15). Tighten screws securely.

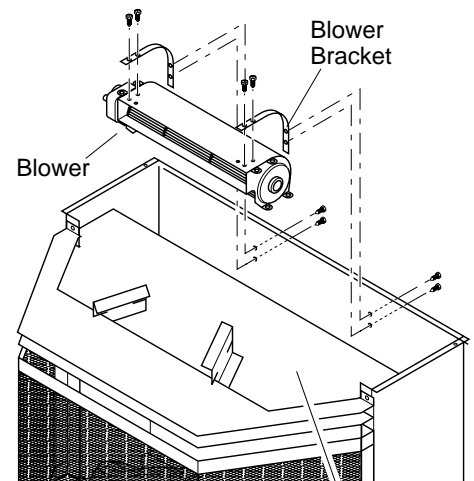

Figure 15 - Removing Blower Brackets from Stove and Attaching to Blower

OWNER'S MANUAL

INSTALLATION

Continued

13. Install plastic control knob onto output shaft of speed control housing (see Figure 16). Place speed control housing just inside control compartment door in front of stove (see Figure 17).
14. Using two screws provided in blower kit, mount blower speed control housing to mounting tab in left side of lower control compartment (see Figure 17).
15. Check to make sure that the power cord is completely clear of blower wheel and there are no foreign objects in blower wheel.
16. Carefully replace stove top panel. Align holes and replace six screws removed in step 1, page 10.
17. Peel off the backing paper and stick the supplied wiring diagram decal on the stove floor as shown in Figure 16.
18. Plug power cord into a convenient 3-prong grounded wall receptacle near the stove.

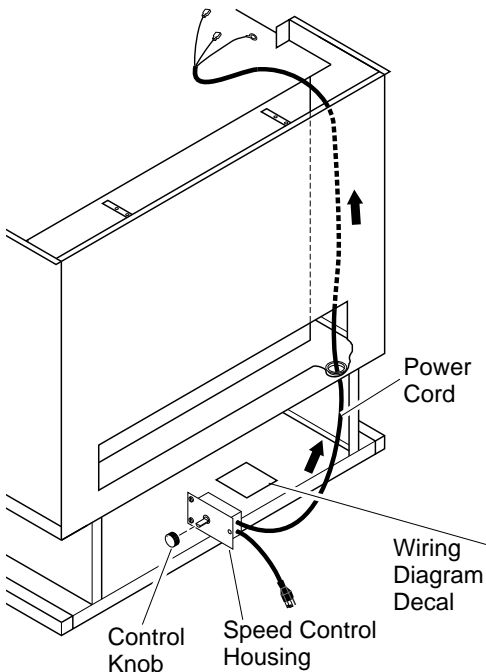

Figure 16 - Routing Power Cord

⚠ WARNING: ELECTRICAL GROUNDING INSTRUCTIONS
 This appliance is equipped with a three-prong (grounding) plug for your protection against shock hazard and should be plugged directly into a properly grounded three-prong receptacle.

19. Using speed control knob, turn blower on and check for operation.
20. All remaining parts from blower kit may be discarded.

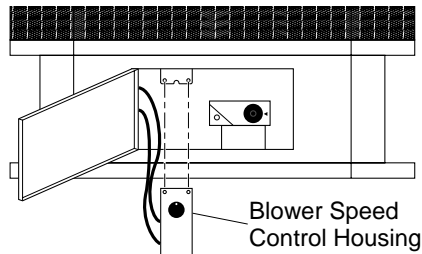
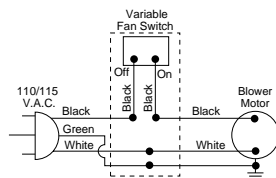

Figure 17 - Installing Blower Control Housing

⚠ WARNING: Never attempt to service heater while it is plugged in, operating, or hot. Burns and electrical shock could result. Only a qualified service person should service or repair heater.

If any of the original wire as supplied with the appliance must be replaced, it must be replaced with 105°C wire or it's equivalent.

⚠ WARNING: Label all wires prior to disconnection when servicing controls. Wiring errors can cause improper and dangerous operation. Verify proper operation after servicing.



120 Vac. 60 Hz. 78 Amps
 DESA International, Bowling Green, KY 101584-05

OPERATING HEATER

**FOR YOUR SAFETY
 READ BEFORE
 LIGHTING**

⚠ WARNING: If you do not follow these instructions exactly, a fire or explosion may result causing property damage, personal injury or loss of life.

- A. This appliance has a pilot which must be lighted by hand. When lighting the pilot, follow these instructions exactly.
- B. **BEFORE LIGHTING** smell all around the appliance area for gas. Be sure to smell next to the floor because some gas is heavier than air and will settle on the floor.

WHAT TO DO IF YOU SMELL GAS

- Do not try to light any appliance.
 - Do not touch any electric switch; do not use any phone in your building.
 - Immediately call your gas supplier from a neighbor's phone. Follow the gas supplier's instructions.
 - If you cannot reach your gas supplier, call the fire department.
- C. Use only your hand to push in or turn the gas control knob. Never use tools. If the knob will not push in or turn by hand, don't try to repair it, call a qualified service technician or gas supplier. Force or attempted repair may result in a fire or explosion.
 - D. Do not use this appliance if any part has been under water. Immediately call a qualified service technician to inspect the appliance and to replace any part of the control system and any gas control which has been under water.

Continued



VENT-FREE PROPANE/LP PEDESTAL STOVE

OPERATING HEATER

Continued

LIGHTING INSTRUCTIONS

NOTICE: During initial operation of new heater, burning logs will give off a paper-burning smell. Orange flame will also be present. Open a window to vent smell. This will only last a few hours.

1. STOP! Read the safety information, page 11, column 3.
2. Make sure equipment shutoff valve is fully open.
3. Turn control knob clockwise  to the OFF position.
4. Wait five (5) minutes to clear out any gas. Then smell for gas, including near the floor. If you smell gas, STOP! Follow "B" in the safety information, page 11, column 3. If you don't smell gas, go to the next step.
5. Turn control knob counterclockwise  to the PILOT position. Press in control knob for five (5) seconds (see Figure 18).

Note: You may be running this heater for the first time after hooking up to gas supply. If so, the control knob may need to be pressed in for 30 seconds or less. This will allow air to bleed from the gas system.

6. With control knob pressed in, press and release ignitor button. This will light pilot. The pilot is attached to the front burner. If needed, keep pressing ignitor button until pilot lights.

Note: If pilot does not stay lit, contact a qualified service person or gas supplier for repairs. Until repairs are made, light pilot with match. To light pilot with match, see *Manual Lighting Procedure*.

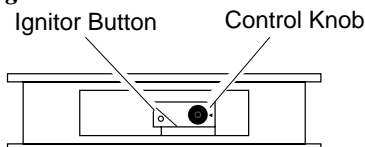



Figure 18 - Control Knob and Ignitor Button Location

7. Keep control knob pressed in for 30 seconds after lighting pilot. After 30 seconds, release control knob.
 - If control knob does not pop out when released, contact a qualified service person or gas supplier for repairs.

Note: If pilot goes out, repeat steps 3 through 7. This heater has a safety interlock system. Wait one (1) minute for system to reset before lighting pilot again.

8. Turn control knob counterclockwise  to desired heating level. The burners should light. Set control knob to any heat level between HI and LO.

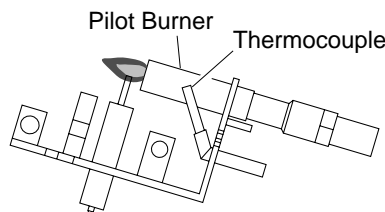

Figure 19 - Pilot

CAUTION: Do not try to adjust heating levels by using the equipment shutoff valve.

TO TURN OFF GAS TO APPLIANCE

Shutting Off Heater

Turn control knob clockwise  to the OFF position.

Shutting Off Burners Only (pilot stays lit)

Turn control knob clockwise  to the PILOT position.

THERMOSTAT CONTROL OPERATION

The thermostat control knob can be set to any comfort level between Hi and Lo. The thermostat will gradually modulate the heat output and flame height from higher to lower settings, or pilot, in order to maintain the comfort level you select. The ideal comfort setting will vary by household depending upon the amount of space to be heated, the output of the central heating system, etc.

Note: Selecting the Hi setting with the control knob will cause the burners to remain fully on, without modulating down in most cases.

MANUAL LIGHTING PROCEDURE

1. Follow steps 1 through 5 under *Lighting Instructions*.
2. Depress control knob and light pilot with match.
3. Keep control knob pressed in for 30 seconds after lighting pilot. After 30 seconds, release control knob. Now follow step 8 in column 2.

INSPECTING BURNERS

Check pilot flame pattern and burner flame patterns often.

PILOT FLAME PATTERN

Figure 20 shows a correct pilot flame pattern. Figure 21 shows an incorrect pilot flame pattern. The incorrect pilot flame is not touching the thermocouple. This will cause the thermocouple to cool. When the thermocouple cools, the heater will shut down.

If pilot flame pattern is incorrect, as shown in Figure 21

- turn heater off (see *To Turn Off Gas to Appliance*)
- see *Troubleshooting*, pages 14 through 16

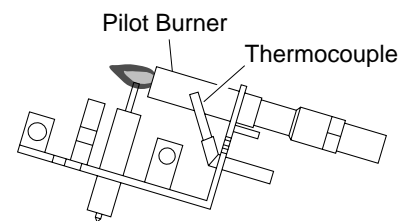

Figure 20 - Correct Pilot Flame Pattern

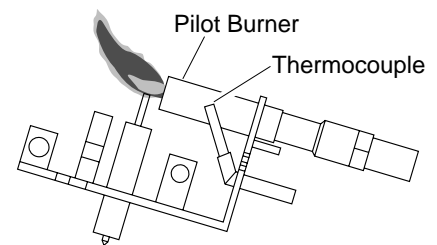

Figure 21 - Incorrect Pilot Flame Pattern

INSPECTING BURNERS

Continued

BURNER FLAME PATTERN

Figure 22 shows a correct burner flame pattern. Figure 23 shows an incorrect burner flame pattern. If burner flame pattern is incorrect,

- turn heater off (see *To Turn Off Gas to Appliance*, page 12)
- see *Troubleshooting*, pages 14 through 16

Approx. 3-6" Above
Top of Logs

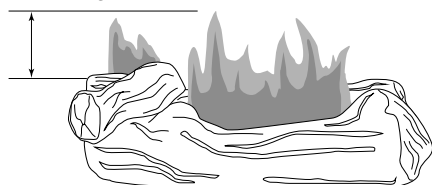

Figure 22 - Correct Flame Pattern with Control Knob Set to High Flame.

More Than 8"
Above Top of Logs

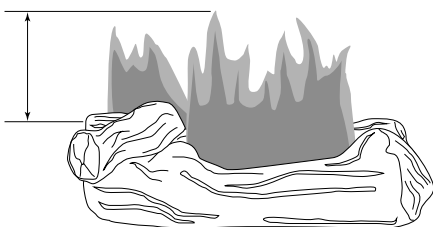

Figure 23 - Incorrect Flame Pattern with Control Knob Set to High Flame

CLEANING AND MAINTENANCE

⚠ WARNING: Turn off heater and let cool before cleaning.

⚠ CAUTION: You must keep control areas, burner, and circulating air passageways of heater clean. Inspect these areas of heater before each use. Have heater inspected yearly by a qualified service person. Heater may need more frequent cleaning due to excessive lint from carpeting, bedding material, pet hair, etc.

CLEANING BURNER INJECTOR HOLDER AND PILOT AIR INLET HOLE

The primary air inlet holes allow the proper amount of air to mix with the gas. This provides a clean burning flame. Keep these holes clear of dust, dirt, lint, and pet hair. Clean these air inlet holes prior to each heating season. Blocked air holes will create soot. We recommend that you clean the unit every three months during operation and have heater inspected yearly by a qualified service person.

We also recommend that you keep the burner tube and pilot assembly clean and free of dust and dirt. To clean these parts we recommend using compressed air no greater than 30 PSI. Your local computer store, hardware store, or home center may carry compressed air in a can. You can use a vacuum cleaner in the blow position. If using compressed air in a can, please follow the directions on the can. If you don't follow directions on the can, you could damage the pilot assembly.

1. Shut off the unit, including the pilot. Allow the unit to cool for at least thirty minutes.
2. Inspect burner, pilot, and primary air inlet holes on injector holder for dust and dirt (see Figure 24).
3. Blow air through the ports/slots and holes in the burner.
4. Check the injector holder located at the end of the burner tube again. Remove any large particles of dust, dirt, lint, or pet hair with a soft cloth or vacuum cleaner nozzle.
5. Blow air into the primary air holes on the injector holder.
6. In case any large clumps of dust have now been pushed into the burner repeat steps 3 and 4.

Clean the pilot assembly also. A yellow tip on the pilot flame indicates dust and dirt in the pilot assembly. There is a small pilot air inlet hole about two inches from where the pilot flame comes out of the pilot assembly (see Figure 25). With the unit off, lightly blow air through the air inlet hole. You may blow through a drinking straw if compressed air is not available.

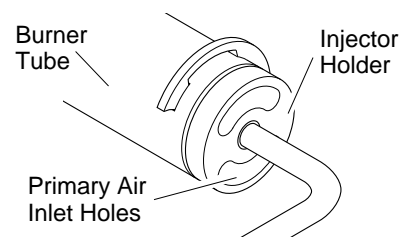

Figure 24 - Injector Holder On Outlet Burner Tube

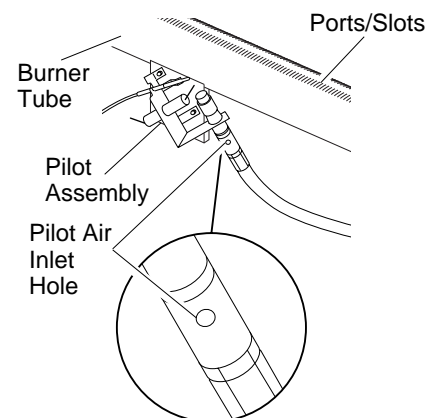

Figure 25 - Pilot Inlet Air Hole

CABINET

Air Passageways

- Use a vacuum cleaner or pressurized air to clean.

Exterior

- Use a soft cloth dampened with a mild soap and water mixture. Wipe the cabinet to remove dust.

LOGS

- If you remove logs for cleaning, refer to *Installing Logs*, page 10, to properly replace logs.
- Replace log(s) if broken or chipped (dime-sized or larger).

MAIN BURNER

Periodically inspect all burner flame holes with the heater running. All slotted burner flame holes should be open with yellow flame present. All round burner flame holes should be open with a small blue flame present. Some burner flame holes may become blocked by debris or rust, with no flame present. If so, turn off heater and let cool. Either remove blockage or replace burner. Blocked burner flame holes will create soot.

Review your video included with your heater for additional cleaning instructions.

VENT-FREE PROPANE/LP PEDESTAL STOVE

TROUBLESHOOTING

Note: For additional help, visit DESA International's technical service web site at www.desatech.com.

⚠ WARNING: Turn off heater and let cool before servicing. Only a qualified service person should service and repair heater.

⚠ CAUTION: Never use a wire, needle, or similar object to clean ODS/pilot. This can damage ODS/pilot unit.

Note: All troubleshooting items are listed in order of operation.

OBSERVED PROBLEM	POSSIBLE CAUSE	REMEDY
When ignitor button is pressed, there is no spark at ODS/pilot	<ol style="list-style-type: none"> 1. Ignitor electrode not connected to ignitor cable 2. Ignitor cable pinched or wet 3. Piezo ignitor nut is loose 4. Broken ignitor cable 5. Bad piezo ignitor 6. Ignitor electrode broken 7. Ignitor electrode positioned wrong 	<ol style="list-style-type: none"> 1. Reconnect ignitor cable 2. Free ignitor cable if pinched by any metal or tubing. Keep ignitor cable dry 3. Tighten nut holding piezo ignitor to base panel of log set. Nut is located behind base panel 4. Replace ignitor cable 5. Replace piezo ignitor 6. Replace piezo ignitor 7. Replace piezo ignitor
When ignitor button is pressed, there is spark at ODS/pilot but no ignition	<ol style="list-style-type: none"> 1. Gas supply turned off or equipment shutoff valve closed 2. Control knob not in PILOT position 3. Control knob not pressed in while in PILOT position 4. Air in gas lines when installed 5. Depleted gas supply 6. ODS/pilot is clogged 7. Gas regulator setting is not correct 	<ol style="list-style-type: none"> 1. Turn on gas supply or open equipment shutoff valve 2. Turn control knob to PILOT position 3. Press in control knob while in PILOT position 4. Continue holding down control knob. Repeat igniting operation until air is removed 5. Contact local propane/LP gas company 6. Clean ODS/pilot (see <i>Cleaning and Maintenance</i>, page 13) or replace ODS/pilot assembly 7. Replace gas control
ODS/pilot lights but flame goes out when control knob is released	<ol style="list-style-type: none"> 1. Control knob not fully pressed in 2. Control knob not pressed in long enough 3. Equipment shutoff valve not fully open 4. Pilot flame not touching thermocouple, which allows thermocouple to cool, causing pilot flame to go out. This problem could be caused by one or both of the following: <ol style="list-style-type: none"> A) Low gas pressure B) Dirty or partially clogged ODS/pilot 5. Thermocouple connection loose at control valve 6. Thermocouple damaged 7. Control valve damaged 	<ol style="list-style-type: none"> 1. Press in control knob fully 2. After ODS/pilot lights, keep control knob pressed in 30 seconds 3. Fully open equipment shutoff valve 4. A) Contact local propane/LP gas company B) Clean ODS/pilot (see <i>Cleaning and Maintenance</i>, page 13) or replace ODS/pilot assembly 5. Hand tighten until snug, then tighten 1/4 turn more 6. Replace thermocouple 7. Replace control valve

OWNER'S MANUAL

TROUBLESHOOTING

Continued

OBSERVED PROBLEM	POSSIBLE CAUSE	REMEDY
Burner does not light after ODS/pilot is lit	<ol style="list-style-type: none">1. Burner orifice clogged2. Inlet gas pressure is too low3. Burner orifice diameter is too small4. Thermopile leads disconnected or improperly connected5. Burners will not come on in remote position	<ol style="list-style-type: none">1. Clean burner (see <i>Cleaning and Maintenance</i>, page 13) or replace burner orifice2. Contact local propane/LP gas company3. Replace burner orifice4. Reconnect leads (see wiring diagram)5. Replace battery in transmitter and receiver
Delayed ignition burner	<ol style="list-style-type: none">1. Manifold pressure is too low2. Burner orifice clogged	<ol style="list-style-type: none">1. Contact local propane/LP gas company2. Clean burner (see <i>Cleaning and Maintenance</i>, page 13) or replace burner orifice
Burner backfiring during combustion	<ol style="list-style-type: none">1. Burner orifice is clogged or damaged2. Damaged burner3. Gas regulator defective	<ol style="list-style-type: none">1. Clean burner (see <i>Cleaning and Maintenance</i>, page 13) or replace burner orifice2. Replace damaged burner3. Replace gas control
Slight smoke or odor during initial operation	<ol style="list-style-type: none">1. Not enough air2. Gas regulator defective3. Residues from manufacturing processes and logs curing	<ol style="list-style-type: none">1. Check burner for dirt and debris. If found, clean burner (see <i>Cleaning and Maintenance</i>, page 13)2. Replace gas control3. Problem will stop after a few hours of operation
Moisture/condensation noticed on windows	<ol style="list-style-type: none">1. Not enough combustion/ventilation air	<ol style="list-style-type: none">1. Refer to <i>Air for Combustion and Ventilation</i> requirements (page 4)
Heater produces a whistling noise when burner is lit	<ol style="list-style-type: none">1. Turning control knob to HI position when burner is cold2. Air in gas line3. Air passageways on heater blocked4. Dirty or partially clogged burner orifice	<ol style="list-style-type: none">1. Turn control knob to LO position and let warm up for a minute2. Operate burner until air is removed from line. Have gas line checked by local propane/LP gas company3. Observe minimum installation clearances (see pages 7 through 9)4. Clean burner (see <i>Cleaning and Maintenance</i>, page 13) or replace burner orifice
Dark residue on logs or inside of fireplace	<ol style="list-style-type: none">1. Improper log placement2. Drafts or other air currents affecting flame pattern3. Air holes at burner inlet blocked4. Burner flame holes blocked	<ol style="list-style-type: none">1. Properly locate logs (see <i>Installing Logs</i>, page 10)2. Eliminate source of drafts around heater3. Clean out air holes at burner inlet. Periodically repeat as needed4. Remove blockage or replace burner
White powder residue forming within burner box or on adjacent walls or furniture	<ol style="list-style-type: none">1. When heated, vapors from furniture polish, wax, carpet cleaners, etc. turn into white powder residue	<ol style="list-style-type: none">1. Turn heater off when using furniture polish, wax, carpet cleaners, or similar products

VENT-FREE PROPANE/LP PEDESTAL STOVE

TROUBLESHOOTING

Continued

- ⚠ WARNING: If you smell gas**
- Shut off gas supply.
 - Do not try to light any appliance.
 - Do not touch any electrical switch; do not use any phone in your building.
 - Immediately call your gas supplier from a neighbor's phone. Follow the gas supplier's instructions.
 - If you cannot reach your gas supplier, call the fire department.

IMPORTANT: Operating heater where impurities in air exist may create odors. Cleaning supplies, paint, paint remover, cigarette smoke, cements and glues, new carpet or textiles, etc., create fumes. These fumes may mix with combustion air and create odors. These odors will disappear over time.

OBSERVED PROBLEM	POSSIBLE CAUSE	REMEDY
Heater produces a clicking/ticking noise just after burner is lit or shut off	1. Metal expanding while heating or contracting while cooling	1. This is common with most heaters. If noise is excessive, contact qualified service person
Heater produces unwanted odors	1. Heater burning vapors from paint, hair spray, glues, cleaners, chemicals, new carpet, etc. (See <i>IMPORTANT</i> statement above) 2. Gas leak. See Warning statement at top of page	1. Open window and ventilate room. Stop using odor causing products while heater is running 2. Locate and correct all leaks (see <i>Checking Gas Connections</i> , page 9)
Heater shuts off in use (ODS operates)	1. Not enough fresh air is available 2. Low line pressure 3. ODS/pilot is partially clogged	1. Open window and/or door for ventilation 2. Contact local propane/LP gas company 3. Clean ODS/pilot (see <i>Cleaning and Maintenance</i> , page 13)
Gas odor even when control knob is in OFF position	1. Gas leak. See Warning statement at top of page 2. Control valve defective	1. Locate and correct all leaks (see <i>Checking Gas Connections</i> , page 9) 2. Replace control valve
Gas odor during combustion	1. Foreign matter between control valve and burner 2. Gas leak. See Warning statement at top of page	1. Take apart gas tubing and remove foreign matter 2. Locate and correct all leaks (see <i>Checking Gas Connections</i> , page 9)
Burner flame is excessively large and is very near or touches the top of firebox	1. Excessive line or manifold pressure 2. Dirty primary air holes	1. Check manifold pressure and correct as needed 2. Clean burner air holes (see <i>Cleaning and Maintenance</i> , page 13).

OWNER'S MANUAL

SPECIFICATIONS

Btu (Variable)	20,000/26,000
Type Gas	Propane/LP Only
Ignition	Piezo
Manifold Pressure	8" W.C.
Inlet Gas Pressure (in. of water) *	
Maximum	14"
Minimum	11"
Dimensions, Inches (H x W x D)	
Stove	24 x 27 1/4 x 17 1/4
Carton	22 x 31 x 31 1/2
Weight, pounds	
Stove	66 lbs.
Shipping	80 lbs.

* For purposes of input adjustment

SERVICE HINTS

When Gas Pressure Is Too Low

- pilot will not stay lit
- burners will have delayed ignition
- heater will not produce specified heat
- propane/LP gas supply may be low

When Gas Quality Is Bad

- pilot will not stay lit
- burners will produce flames and soot
- heater will backfire when lit

You may feel your gas pressure is too low or gas quality is bad. If so, contact your local propane/LP gas supplier.

TECHNICAL SERVICE

You may have further questions about installation, operation, or troubleshooting. If so, contact DESA International's Technical Service Department at 1-800-DESA LOG (1-800-337-2564).

You can also visit DESA International's technical services web site at www.desatech.com.

PARTS CENTRALS

These Parts Centrals are privately owned businesses. They have agreed to support our customer's needs by providing original replacement parts and accessories.

Baltimore Electric

1348 Dixwell Avenue
Hamden, CT 06514-0322
1-800-397-7553
203-248-7553
Parts Department

Portable Heater Parts

342 N. County Rd. 400 East
Valparaiso, IN 46383-9704
All States
219-462-7441
1-800-362-6951
sales@portableheaterparts.com
techservice@portableheaterparts.com

FBD

1349 Adams Street
Bowling Green, KY 42103-3414
270-846-1199
1-800-654-8534
Fax: 1-800-846-0090
franktalk@aol.com

Master Parts Dist.

1251 Mound Ave NW
Grand Rapids, MI 49504-2672
616-791-0505
1-800-446-1446
Fax: 616-791-8270
www.nbmc.com

Washer Equipment Co.

1715 Main Street
Kansas City, MO 64108-2195
KS, MO, AR
816-842-3911
www.washerparts.com

East Coast Energy Products

707 Broadway
W. Long Branch, NJ 07764-1542
732-870-8809
1-800-755-8809
www.njplaza.com/ecep

Dayton Hardware

P.O. Box 275
North Dayton Station
Dayton, OH 45404-0275
All States
937-258-3721
OH 1-800-762-3426

Halco Enterprises

208 Carter Drive, Unit 21
West Chester, PA 19382-4500
610-430-7717
1-800-368-0803
www.halcoenterprises.com

Laporte's Parts & Service

2444 N. 5th Street
Hartsville, SC 29550-7704
803-332-0191
Parts Department

Cans Unlimited, Inc.

P.O. Box 645
Taylor, SC 29687-0013
All States
803-879-3009
1-800-845-5301
cuissales@aol.com

Comfort Glow[®]

VENT-FREE PROPANE/LP PEDESTAL STOVE

ILLUSTRATED PARTS BREAKDOWN

S26PT

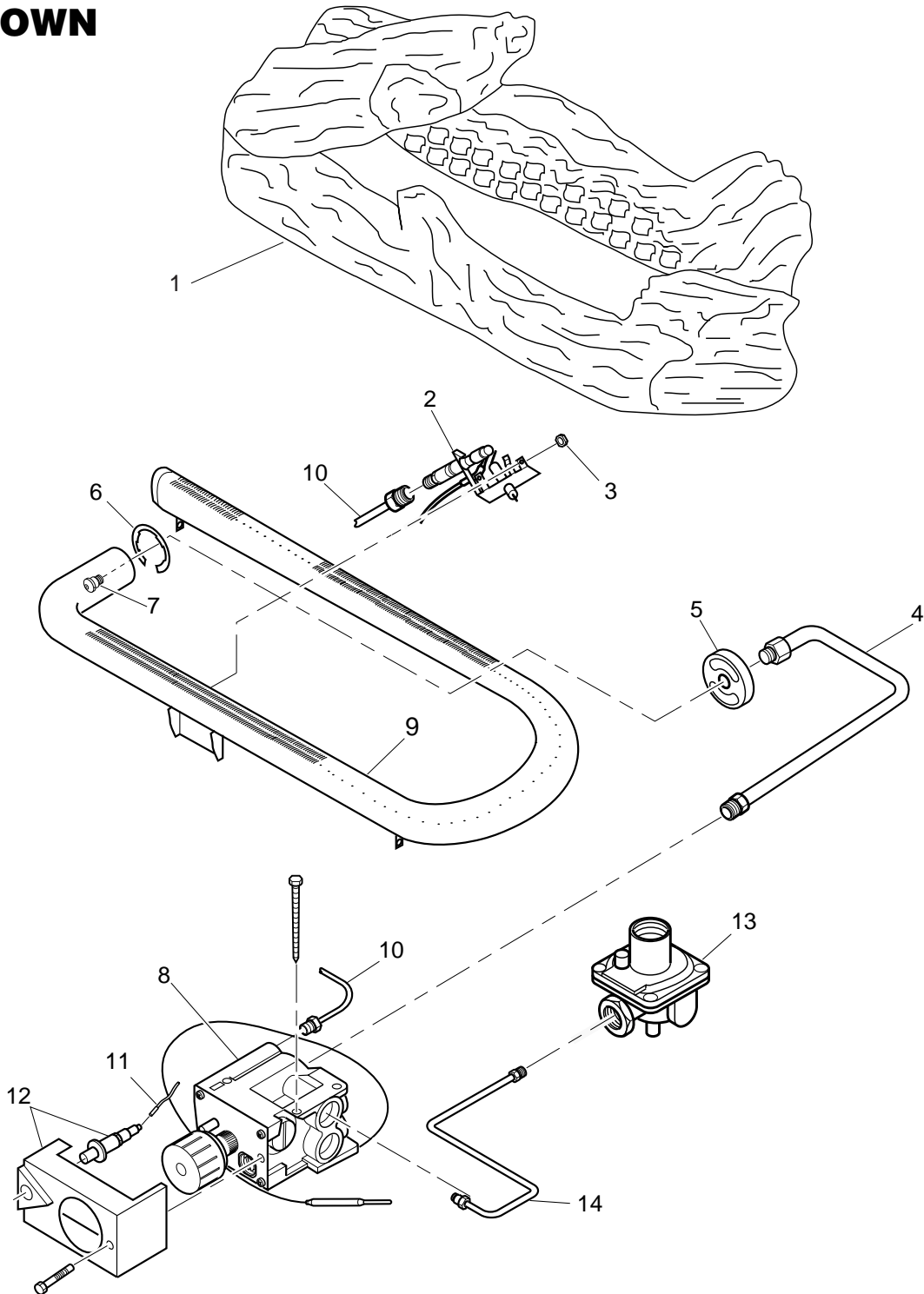

OWNER'S MANUAL

PARTS LIST

This list contains replaceable parts used in your heater. When ordering parts, follow the instructions listed under *Replacement Parts* on page 22 of this manual.

S26PT

KEY NO.	PART NUMBER	DESCRIPTION	QTY.
1	106039-01	Log Set	1
2	104286-01	ODS Pilot (LP)	1
3	098249-01	ODS Nut	2
4	105973-01	Burner Outlet Tube	1
5	105737-02	Injector Holder	1
6	102843-01	Burner Clip	1
7	099056-28	Burner Orifice Injector	1
8	101329-26	Gas Control Valve	1
9	102980-01	Burner	1
10	099387-09	Pilot Tube	1
11	098271-07	Ignitor Cable	1
12	101381-01	Piezo Ignitor and Cover	1
13	098867-10	Regulator	1
14	105972-01	Inlet Tube	1
PARTS AVAILABLE — NOT SHOWN			
	100563-01	Warning Plate	1
	101054-01	Lighting Instructions Plate	1

Comfort Glow[®]

VENT-FREE PROPANE/LP PEDESTAL STOVE

ILLUSTRATED PARTS BREAKDOWN

S26PT

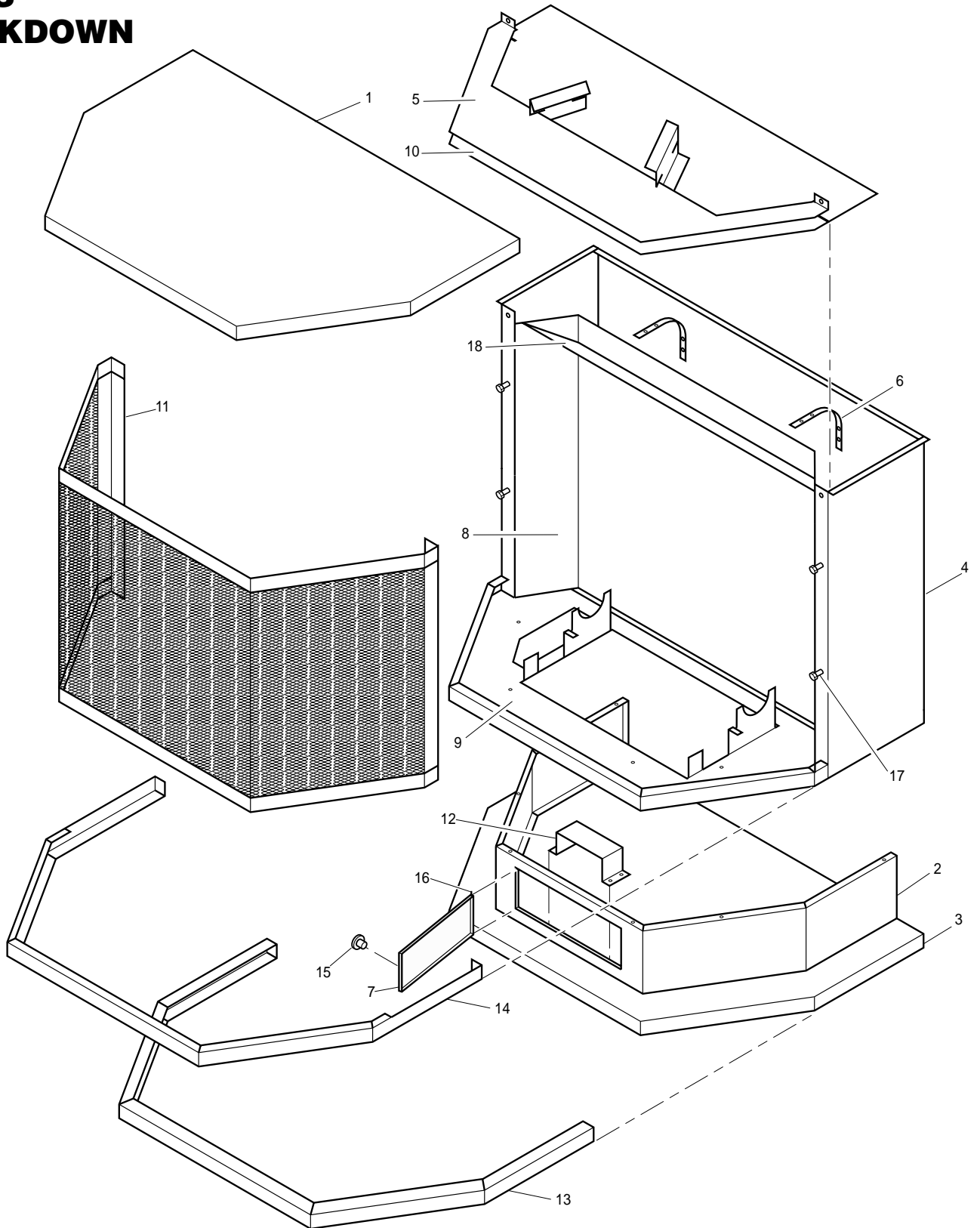

OWNER'S MANUAL

PARTS LIST

This list contains replaceable parts used in your heater. When ordering parts, follow the instructions listed under *Replacement Parts* on page 22 of this manual.

S26PT

KEY NO.	PART NO.	DESCRIPTION	QTY.
1	105666-01	Top Panel, Stove	1
2	105656-01	Pedestal Stove	1
3	105655-01	Stove Base	1
4	105654-01	Stove Back Panel	1
5	105653-01	Louver Panel	1
6	105657-01	Blower Bracket	2
7	105658-01	Door	1
8	105659-01	Firebox Back Panel	1
9	105660-01	Firebox Floor	1
10	105661-01	Firebox Top Assembly	1
11	105970-01	Screen Assembly	1
12	101382-01	Valve Bracket	1
13	105672-01	Brass Trim, Bottom	1
14	105673-01	Brass Trim, Firebox	1
15	106754-01	Knob	1
16	105971-01	Door Hinge	1
17	099230-02	Shoulder Screw	4
18	106020-01	Heat Deflector	1
PARTS AVAILABLE — NOT SHOWN			
	101054-01	Lighting Instructions Plate	1
	100563-01	Warning Plate	1
	104310-10	Information Video	1
	104108-06	Touch-Up Paint Kit	1

VENT-FREE PROPANE/LP PEDESTAL STOVE

REPLACEMENT PARTS

Note: Use only original replacement parts. This will protect your warranty coverage for parts replaced under warranty.

PARTS UNDER WARRANTY

Contact authorized dealers of this product. If they can't supply original replacement part(s) call DESA International's Technical Service Department at 1-800-323-5190 for referral information.

When calling DESA International, have ready

- your name
- your address
- model and serial numbers of your heater
- how heater was malfunctioning
- type of gas used (propane/LP or natural gas)
- purchase date

Usually, we will ask you to return the defective part to the factory.

PARTS NOT UNDER WARRANTY

Contact authorized dealers of this product or Parts Central (see page 17). If they can't supply original replacement part(s) call DESA International's Parts Department at 1-800-972-7879 for referral information.

When calling DESA International, have ready

- model number of your heater
- the replacement part number

ACCESSORIES

Purchase these heater accessories from your local dealer or Parts Central (see page 17). If they cannot supply these accessories call DESA International's Sales Department at 1-800-458-2472 for referral information. You can also write to the address listed on the back page of this manual.

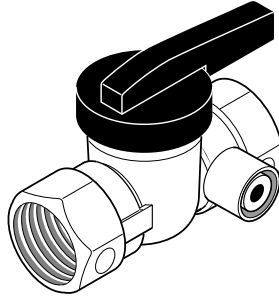

EQUIPMENT SHUTOFF VALVE - GA5010

Equipment shutoff valve with 1/8" NPT tap.

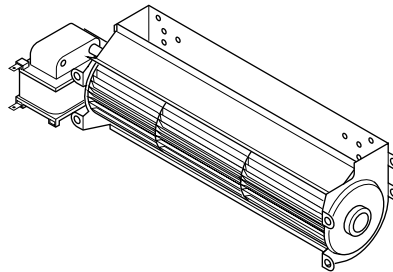

MANUALLY-CONTROLLED BLOWER KIT - GA3750

Provides better heat distribution. Features variable speed control knob.

CLEANING KIT - CCK (Not Shown)

Your vent-free gas appliance requires regular cleaning and maintenance to prevent performance problems. This kit gives you the tools and instructions to make it easy to clean all critical areas of your appliance.

WARRANTY INFORMATION

KEEP THIS WARRANTY

Model _____
Serial No. _____
Date Purchased _____

Always specify model and serial numbers when communicating with the factory.

We reserve the right to amend these specifications at any time without notice. The only warranty applicable is our standard written warranty. We make no other warranty, expressed or implied.

LIMITED WARRANTY VENT-FREE PROPANE/LP GAS PEDESTAL STOVE

DESA International warrants this product to be free from defects in materials and components for two (2) years from the date of first purchase, provided that the product has been properly installed, operated and maintained in accordance with all applicable instructions. To make a claim under this warranty the Bill of Sale or cancelled check must be presented.

This warranty is extended only to the original retail purchaser. This warranty covers the cost of part(s) required to restore this heater to proper operating condition and an allowance for labor when provided by a DESA Authorized Service Center. Warranty part(s) MUST be obtained through authorized dealers of this product and/or DESA International who will provide original factory replacement parts. Failure to use original factory replacement parts voids this warranty. The heater MUST be installed by a qualified installer in accordance with all local codes and instructions furnished with the unit.

This warranty does not apply to parts that are not in original condition because of normal wear and tear, or parts that fail or become damaged as a result of misuse, accidents, lack of proper maintenance or defects caused by improper installation. Travel, diagnostic cost, labor, transportation and any and all such other costs related to repairing a defective heater will be the responsibility of the owner.

TO THE FULL EXTENT ALLOWED BY THE LAW OF THE JURISDICTION THAT GOVERNS THE SALE OF THE PRODUCT; THIS EXPRESS WARRANTY EXCLUDES ANY AND ALL OTHER EXPRESSED WARRANTIES AND LIMITS THE DURATION OF ANY AND ALL IMPLIED WARRANTIES, INCLUDING WARRANTIES OF MERCHANTABILITY AND FITNESS FOR A PARTICULAR PURPOSE TO TWO (2) YEARS ON ALL COMPONENTS FROM THE DATE OF FIRST PURCHASE; AND DESA INTERNATIONAL'S LIABILITY IS HEREBY LIMITED TO THE PURCHASE PRICE OF THE PRODUCT AND DESA INTERNATIONAL SHALL NOT BE LIABLE FOR ANY OTHER DAMAGES WHATSOEVER INCLUDING INDIRECT, INCIDENTAL OR CONSEQUENTIAL DAMAGES.

Some states do not allow a limitation on how long an implied warranty lasts or an exclusion or limitation of incidental or consequential damages, so the above limitation on implied warranties, or exclusion or limitation on damages may not apply to you.

This warranty gives you specific legal rights, and you may also have other rights that vary from state to state.

For information about this warranty write:

DESA
INTERNATIONAL
2701 Industrial Drive
P.O. Box 90004
Bowling Green, KY 42102-9004
www.desatech.com



105684 01

NOT A UPC

105684-01
Rev. C
09/00